

230V
50-60Hz
3p = 6h

400V
50-60Hz
4p, 5p = 6h

500V
50-60Hz
4p, 5p = 7h



Prúd

Napätie

Póly

Krytie

Hodinový uhol

Typ

Balenie ks

Hmotnosť g/ks

Rozmery strana/obr.



Adaptér – zmena 5P na 4P.

16 A	400 V	5/4	IP 44	6 h	A 1653/43	9	284	27/59
32 A	400 V	5/4	IP 44	6 h	A 3253/43	6	457	27/59

Využitie adaptéra A 5p/4p je podmienené symetrickou záťažou, pretože 4-pólová zásuvka má zapojenie 3P+PE.



Adaptér – zmena 16A na 32A.

16 A/32A	400 V	4	IP 44	6 h	A 16-32/4	8	343	27/60
16 A/32A	400 V	5	IP 44	6 h	A 16-32/5	8	386	27/60



Adaptér – zmena sledu fáz.

16 A	400 V	4	IP 44	6 h	RA 1643	9	296	27/61
16 A	400 V	5	IP 44	6 h	RA 1653	9	336	27/61
32 A	400 V	4	IP 44	6 h	RA 3243	6	450	27/61
32 A	400 V	5	IP 44	6 h	RA 3253	6	507	27/61



Adaptér – zmena 16A/32A resp. 5P na 4P + možnosť zmeny fáz.

16A/32A	400 V	5	IP 44	6 h	A 16-32/5-0	8	386	27/62
16 A	400 V	5/4	IP 44	6 h	A 1653/43-0	9	284	27/62
32 A	400 V	5/4	IP 44	6 h	A 3253/43-0	6	470	27/62

Pootočením otočného dielu pomocou skrutkovača o 180 ° je možné zameniť polohu kolíkov, a tým sa dosiahne zmena fáz.

Využitie adaptéra A 5p/4p je podmienené symetrickou záťažou, pretože 4-pólová zásuvka má zapojenie 3P+PE.



Redukcia z priemyselnej vidlice 3P/16A/ 230V na domovú zásuvku 250V/16A, S – Schuko.

16A	230 V	3	IP 44	6 h	SA-1	4	219	28/63
16A	230 V	3	IP 44	6 h	SA-1S	4	219	28/63

SA-1



Redukcia z priemyselnej vidlice 5P/16A/ 400V na domovú zásuvku 250V/16A, S – Schuko.

16A	400 V	5	IP 44	6 h	SA-2	4	243	28/63
16A	400 V	5	IP 44	6 h	SA-2S	4	243	28/63

SA-2



Redukcia z domovej vidlice 250V/16A na priemyselnú zásuvku 3P/16A/230V resp. 3P/32A/230V.

16 A	250 V	3	IP 44	6 h	SA-3	4	241	28/64
32 A	250 V	3	IP 44	6 h	SA-4	4	322	28/64

SA-3

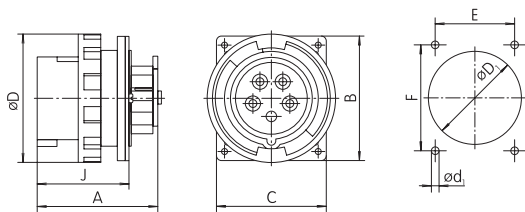
55 IRGR / 16A, 32A

Typ / mm	A	B	C	ød1	øD	øD1	E	F	J
IRGR 1653	80,5	85	75	4	87	65	64	73	59
IRGR 3253	96	95	80	4	100	71	70	84	72

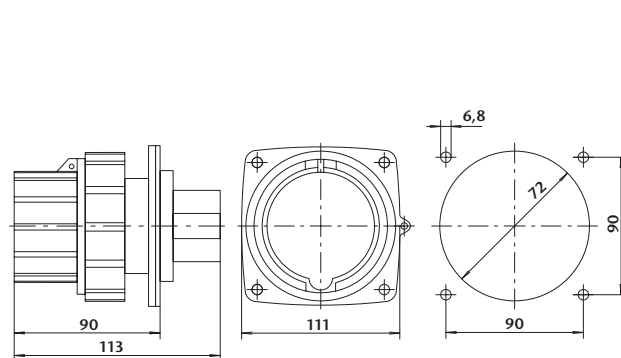
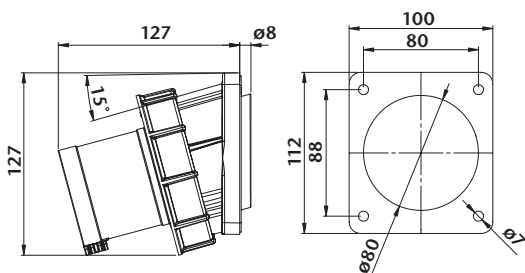
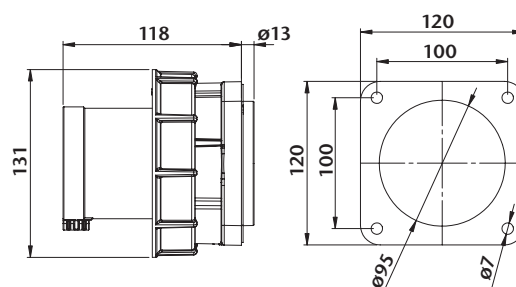
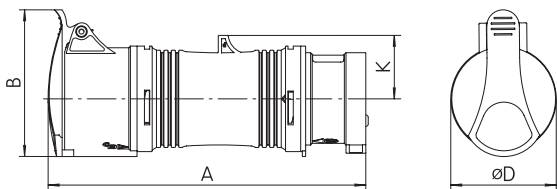
56 IRG / 63A

57 IRGN1 / 63A

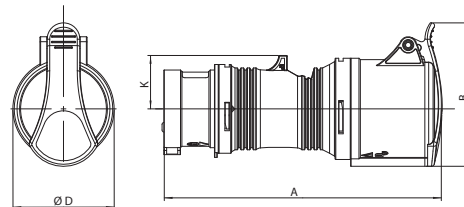
58 IRGN / 125A

59 Adaptér A 5p/4p

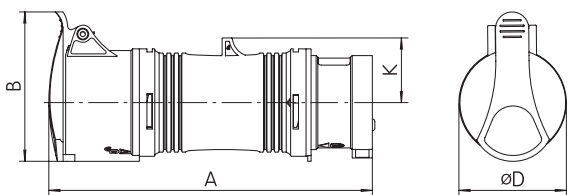
Typ / mm	A	B	øD	K
A 1653/43	180	82	64	39
A 3253/43	235	96	73	45

60 Adaptér A 16-32/x

Typ / mm	A	B	øD	K
A 16-32/4	198	96	65	34
A 16-32/5	200	103	73	37

61 Reverzačný adaptér RA

Typ / mm	A	B	øD	K
RA 1643	178	82	56	35
RA 1653	180	89	64	39
RA 3243	235	96	65	41
RA 3253	237	104	73	45

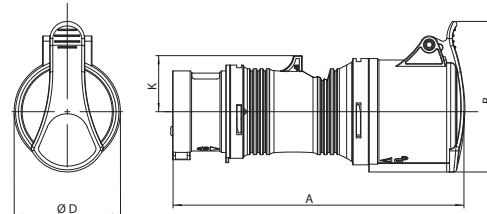
62 Adaptér s reverzačnou prívodkou

Typ / mm	A	B	øD	K
A 1653/43-0	180	82	64	39
A 3253/43-0	235	96	73	45
A 16-32/5-0	200	103	73	37

Poznámka: Pootočením otočného dielu pomocou skrutkovača o 180 stupňov je možné zameniť polohu a tým sa dosiahne zmena fáz.

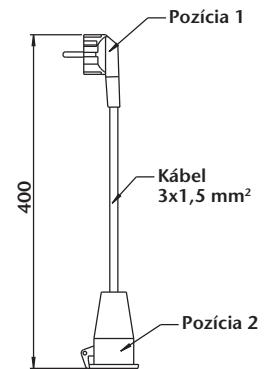
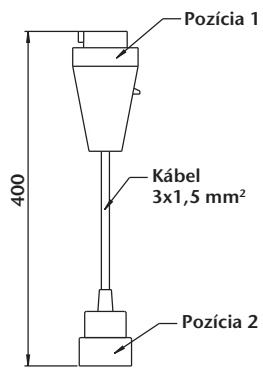

Poznámky

A series of horizontal dotted lines provided for taking notes.